

# ASSEMBLY INSTRUCTIONS









## 383-000094



**IMPORTANT**

**PLEASE READ BEFORE YOU CONTINUE FURTHER**

1. MATERIAL USE LAMINATED PARTICLE BOARD, TO CLEAN USE SOFT, DRY CLOTH.
2. DO NOT USE DETERGENT OR CHEMICAL AVOID CONTACT WITH WATER AND DIRECT SUNLIGHT.
3. TO BE ASSEMBLED ON A SOFT, DRY, CLEAN SMOOTH SURFACE.
4. DO NOT USE ANY TOOLS OTHER THAN THOSE SHOWN.
5. USE OF POWER TOOLS TO ASSEMBLE THIS PRODUCT WILL INVALIDATE ANY CLAIM AND MAY DAMAGE THIS PRODUCT MAKING IT UNSAFE.
6. BEFORE STARTING ASSEMBLY PLEASE VERIFY IF ALL PARTS AND HARDWARE ARE INCLUDED.

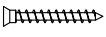

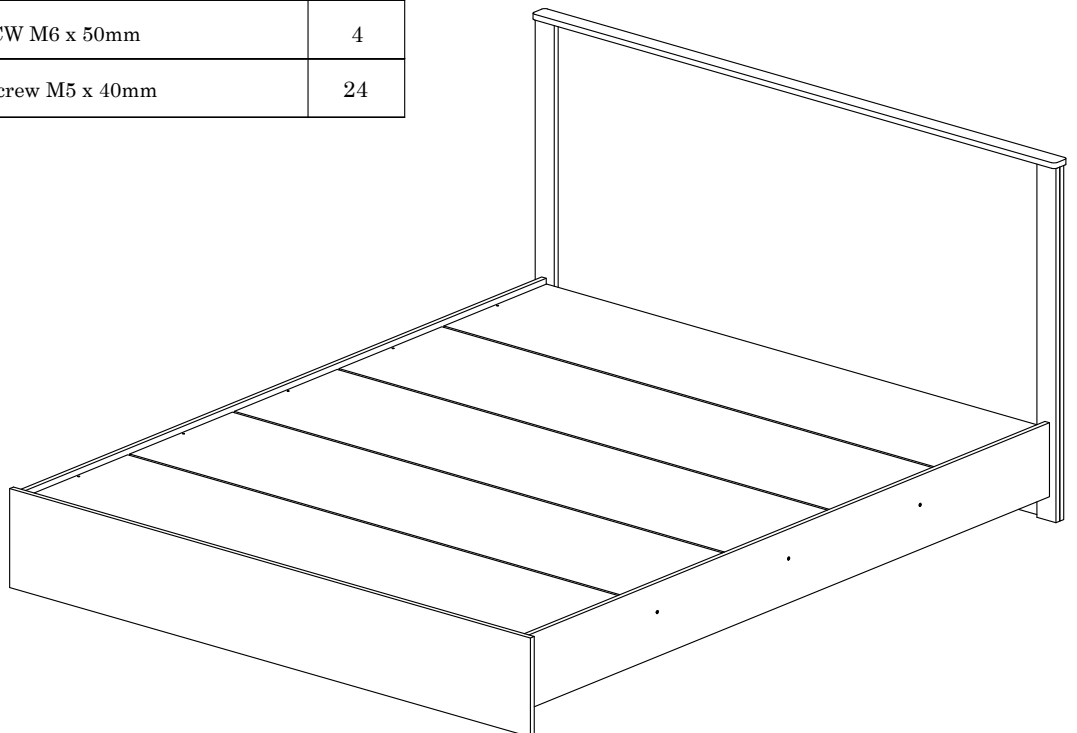
| HARDWARE LIST |   |                     | QTY<br>(pcs) |
|---------------|---|---------------------|--------------|
| DW4           |   | Wood Dowel 6 x 25mm | 51           |
| LG1           |  | Leg Pin             | 10           |
| MF1           |  | Alley Key           | 1            |
| MN2           |  | Mini Fix 15mm       | 12<br>Sets   |
| PF11          |  | Small L Bracket     | 8            |
| SC3           |  | Screw M3.5 x 14mm   | 16           |
| SC13          |  | Screw M4 x 30mm     | 10           |
| SC24          |  | JCBCW M6 x 50mm     | 4            |
| SC25          |  | FH Screw M5 x 40mm  | 24           |

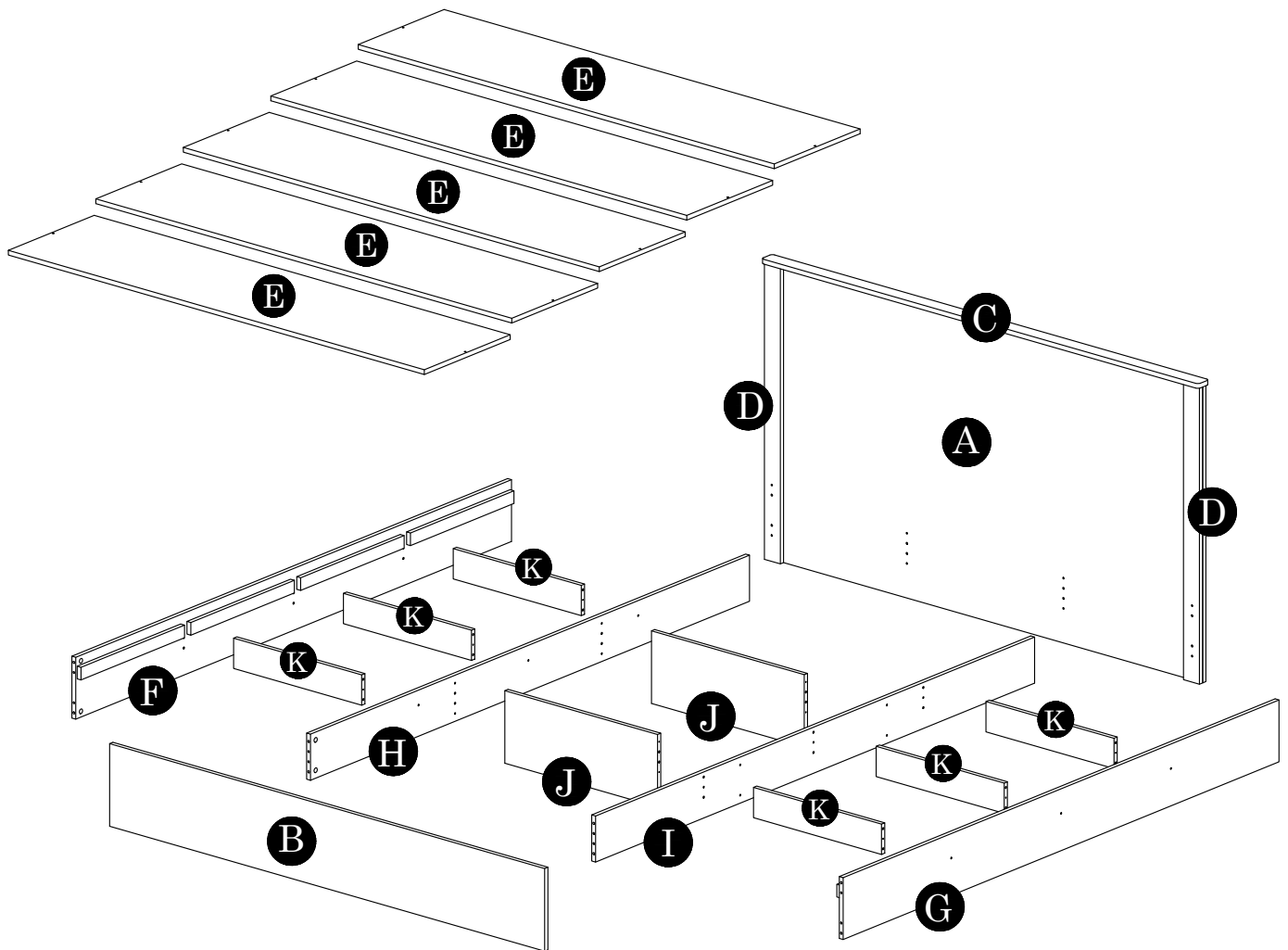

| Parts List |                       | QTY   |
|------------|-----------------------|-------|
| A          | Head Board            | 1 pc  |
| B          | Foot Board            | 1 pc  |
| C          | Head-Top Panel        | 1 pc  |
| D          | Head-Crossbar Panel   | 2 pcs |
| E          | Bed Base Panel        | 5 pcs |
| F          | Side Panel (L)        | 1 pc  |
| G          | Side Panel (R)        | 1 pc  |
| H          | Center Panel (L)      | 1 pc  |
| I          | Center Panel (R)      | 1 pc  |
| J          | Big Crossbar          | 2 pcs |
| K          | Small Center Crossbar | 6 pcs |
| L          | Small Wood            | 8 pcs |



# STEP 1

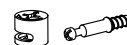

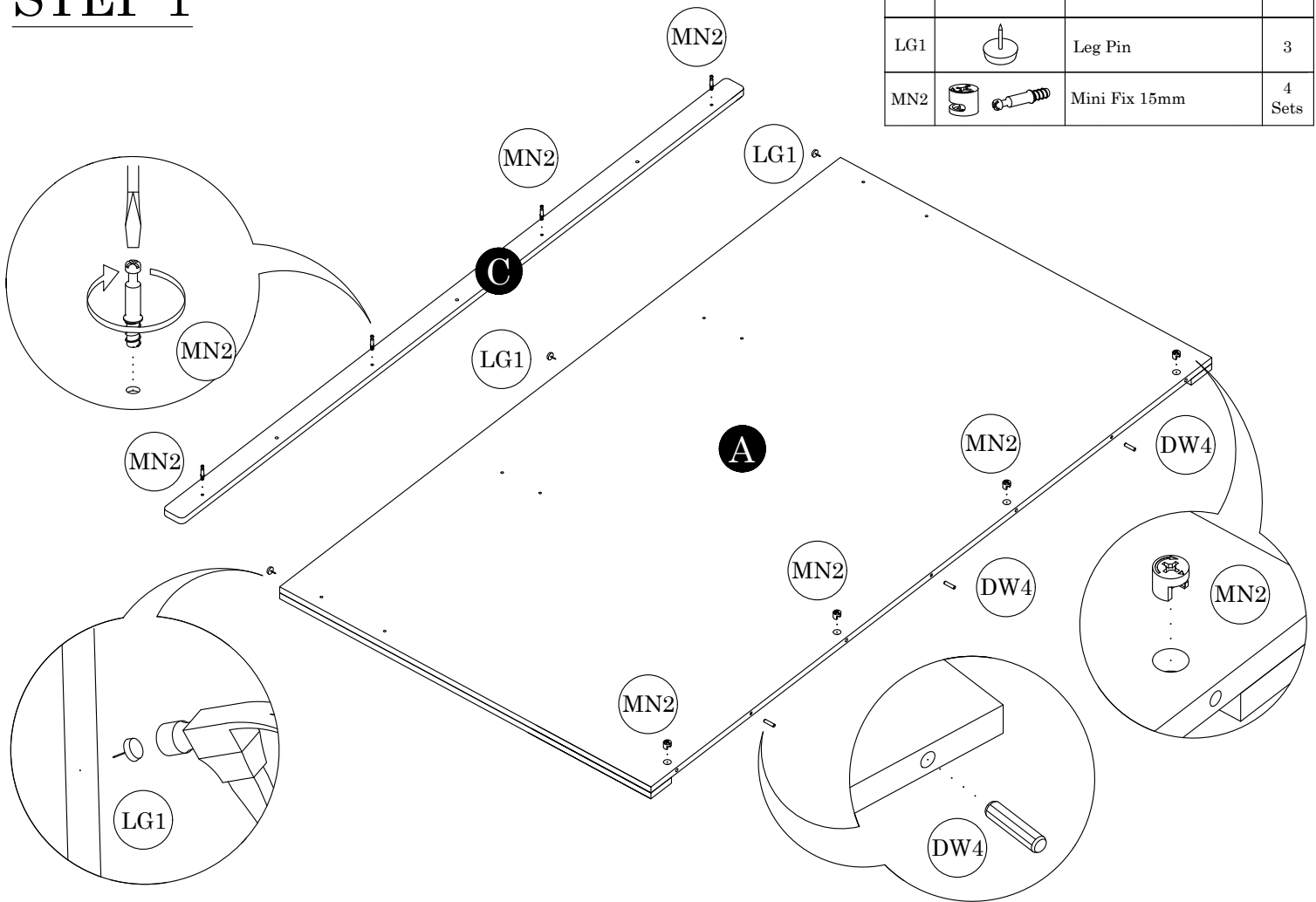
|     |   |                     |        |
|-----|---|---------------------|--------|
| DW4 |    | Wood Dowel 6 x 25mm | 3      |
| LG1 |  | Leg Pin             | 3      |
| MN2 |  | Mini Fix 15mm       | 4 Sets |

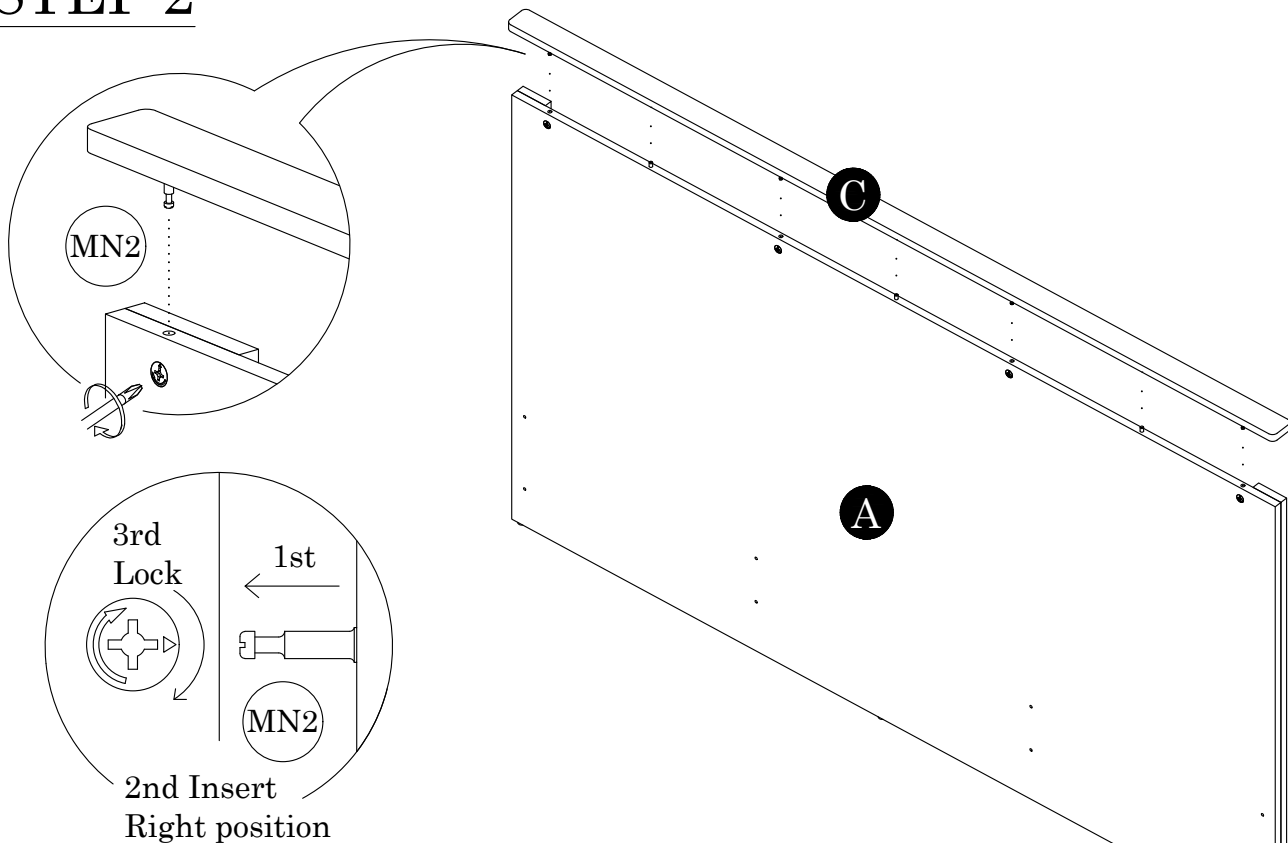

# STEP 2



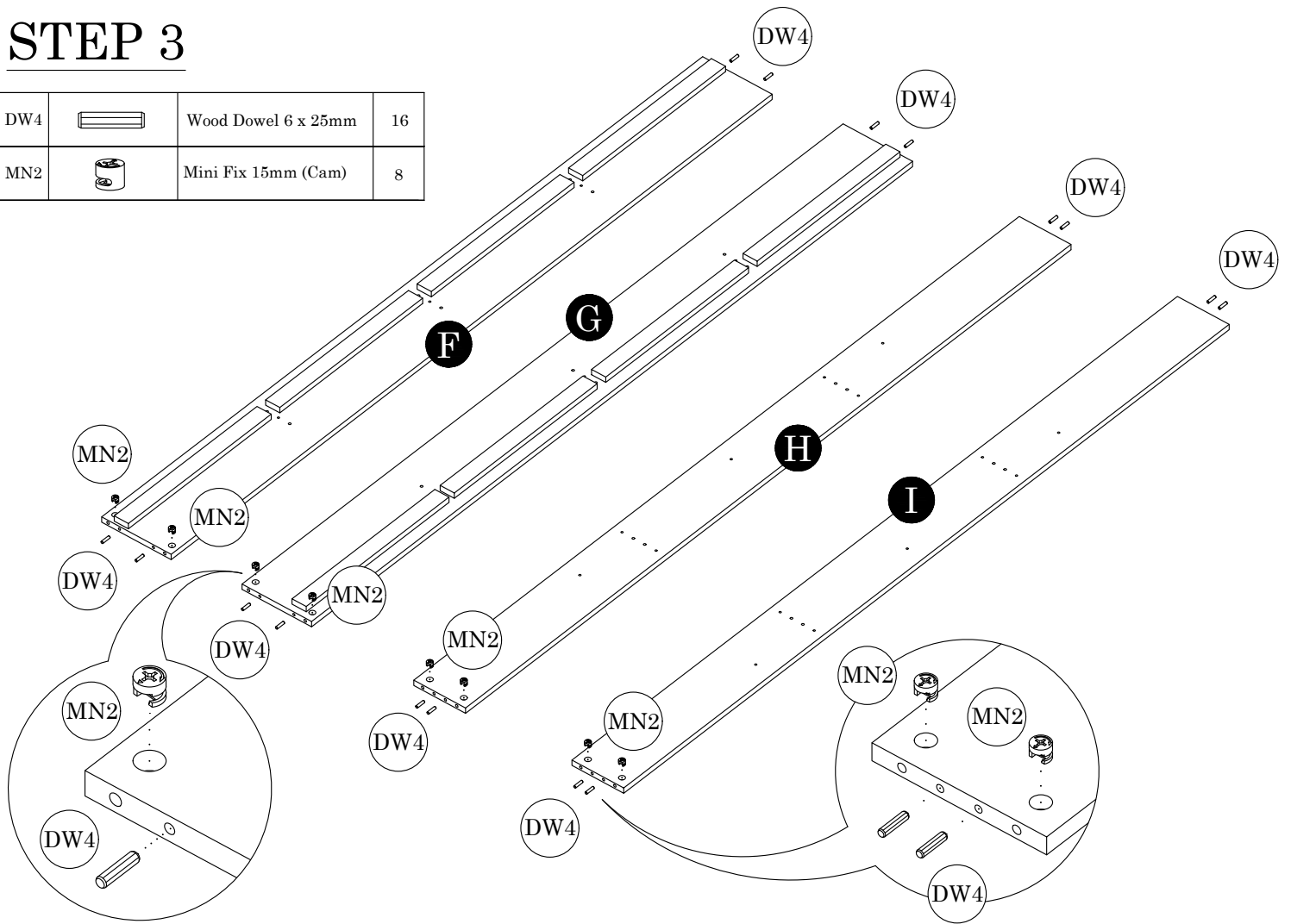

# STEP 3

|     |   |                     |    |
|-----|---|---------------------|----|
| DW4 |  | Wood Dowel 6 x 25mm | 16 |
| MN2 |  | Mini Fix 15mm (Cam) | 8  |



# STEP 4

|     |   |                      |    |
|-----|---|----------------------|----|
| DW4 |  | Wood Dowel 6 x 25mm  | 32 |
| LG1 |  | Leg Pin              | 7  |
| MN2 |  | Mini Fix 15mm (Bolt) | 8  |

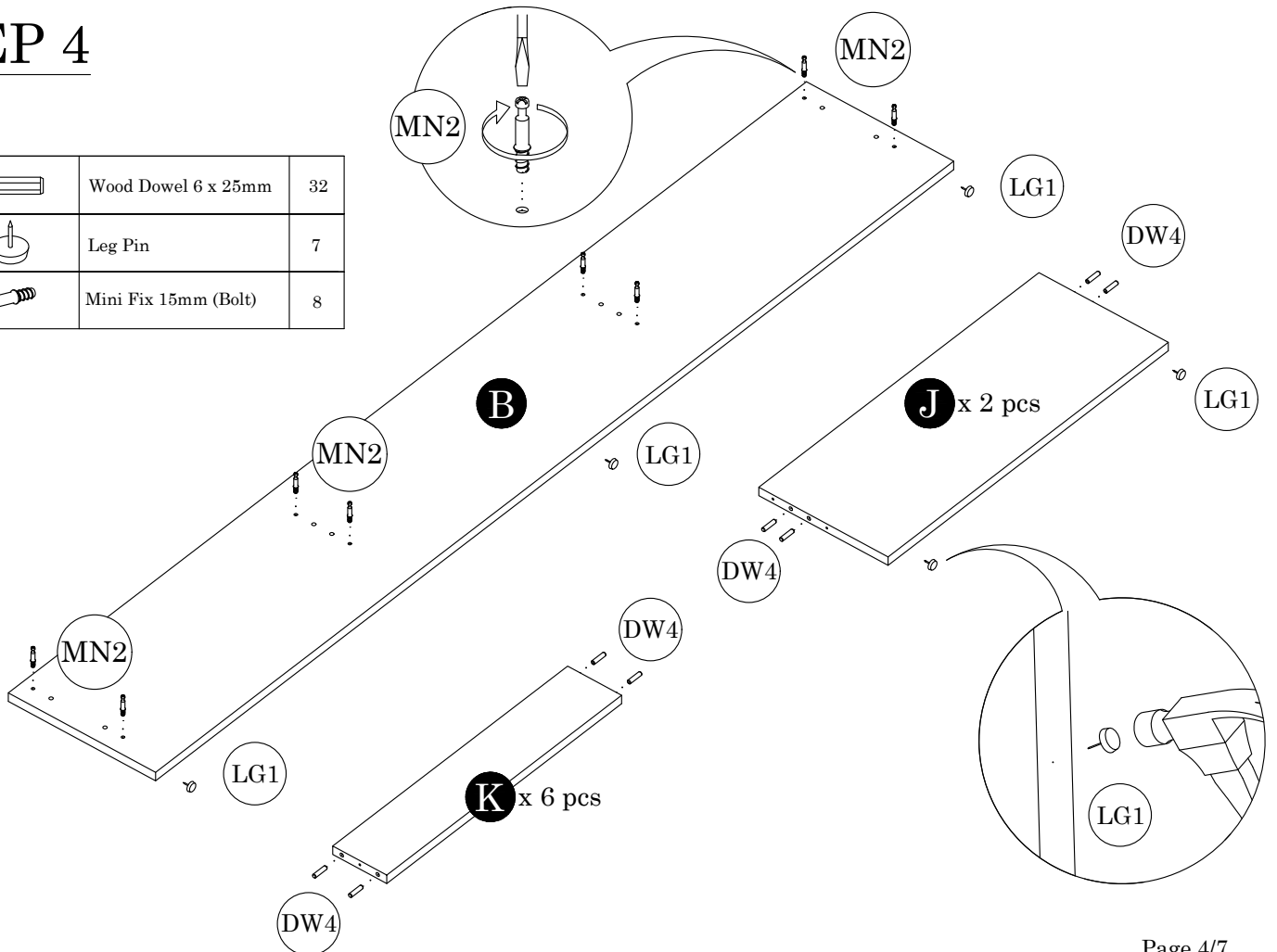

# STEP 5

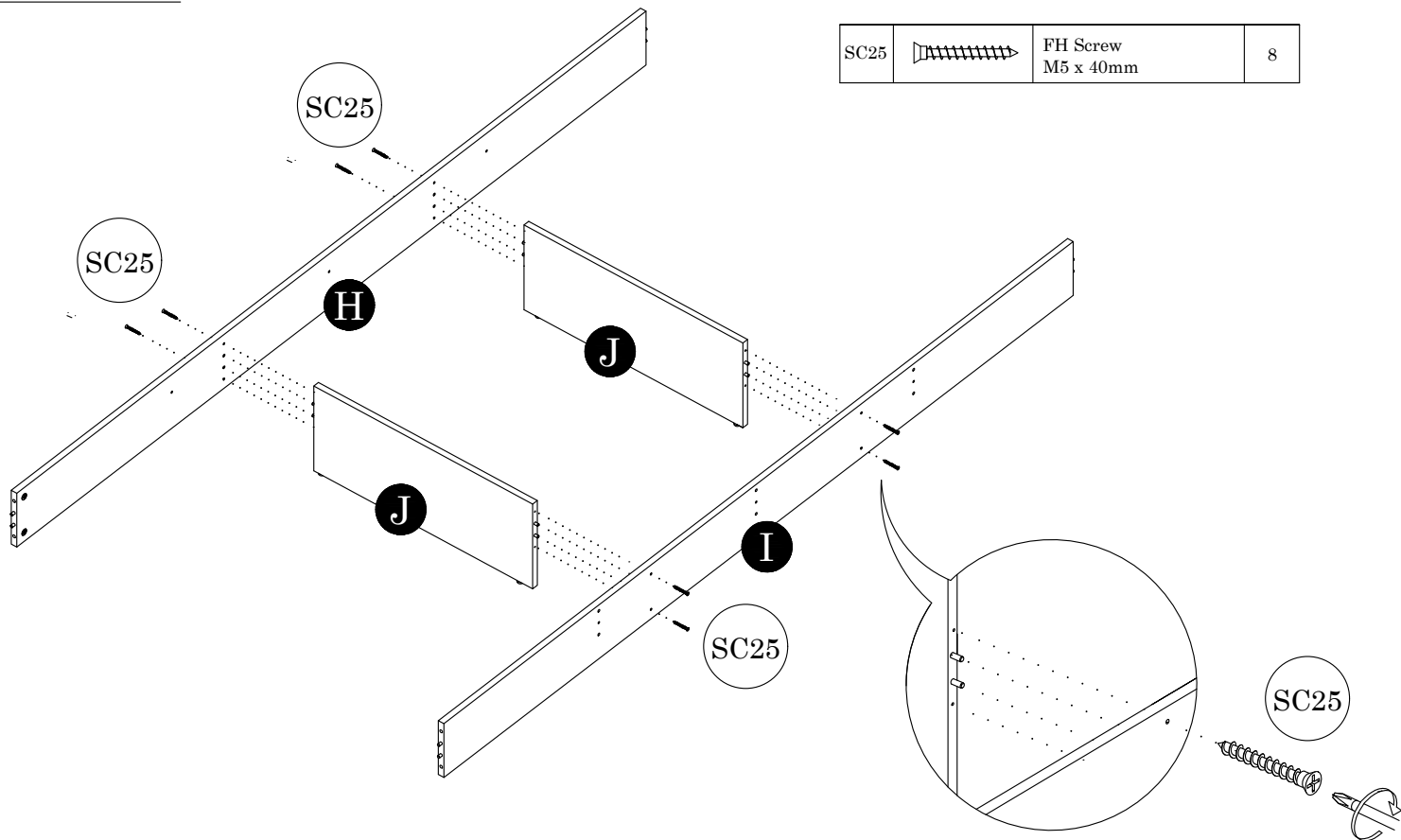

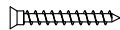
|      |   |                       |   |
|------|---|-----------------------|---|
| SC25 |  | FH Screw<br>M5 x 40mm | 8 |
|------|---|-----------------------|---|

# STEP 6

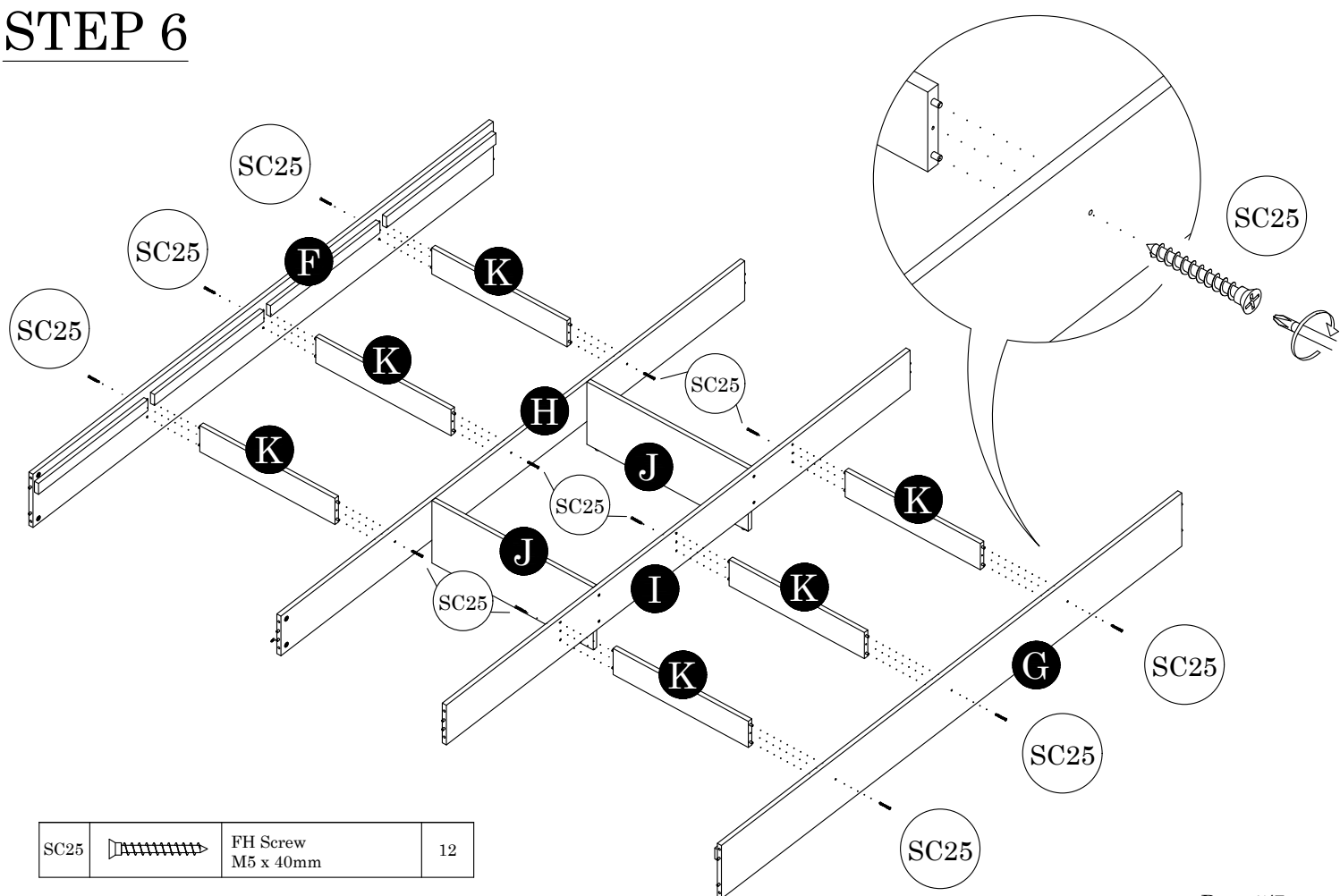

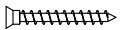
|      |   |                       |    |
|------|---|-----------------------|----|
| SC25 |  | FH Screw<br>M5 x 40mm | 12 |
|------|---|-----------------------|----|

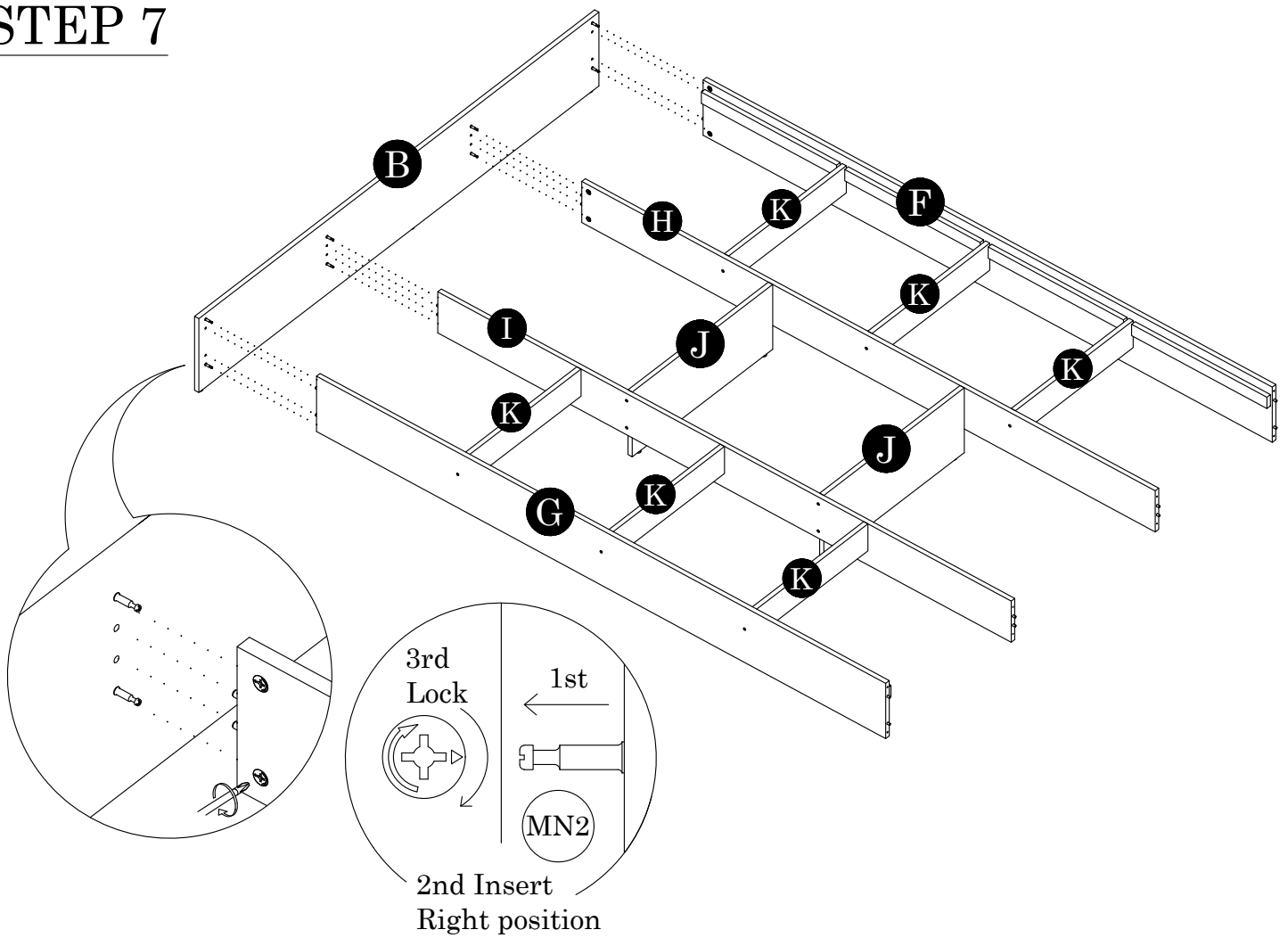

# STEP 7

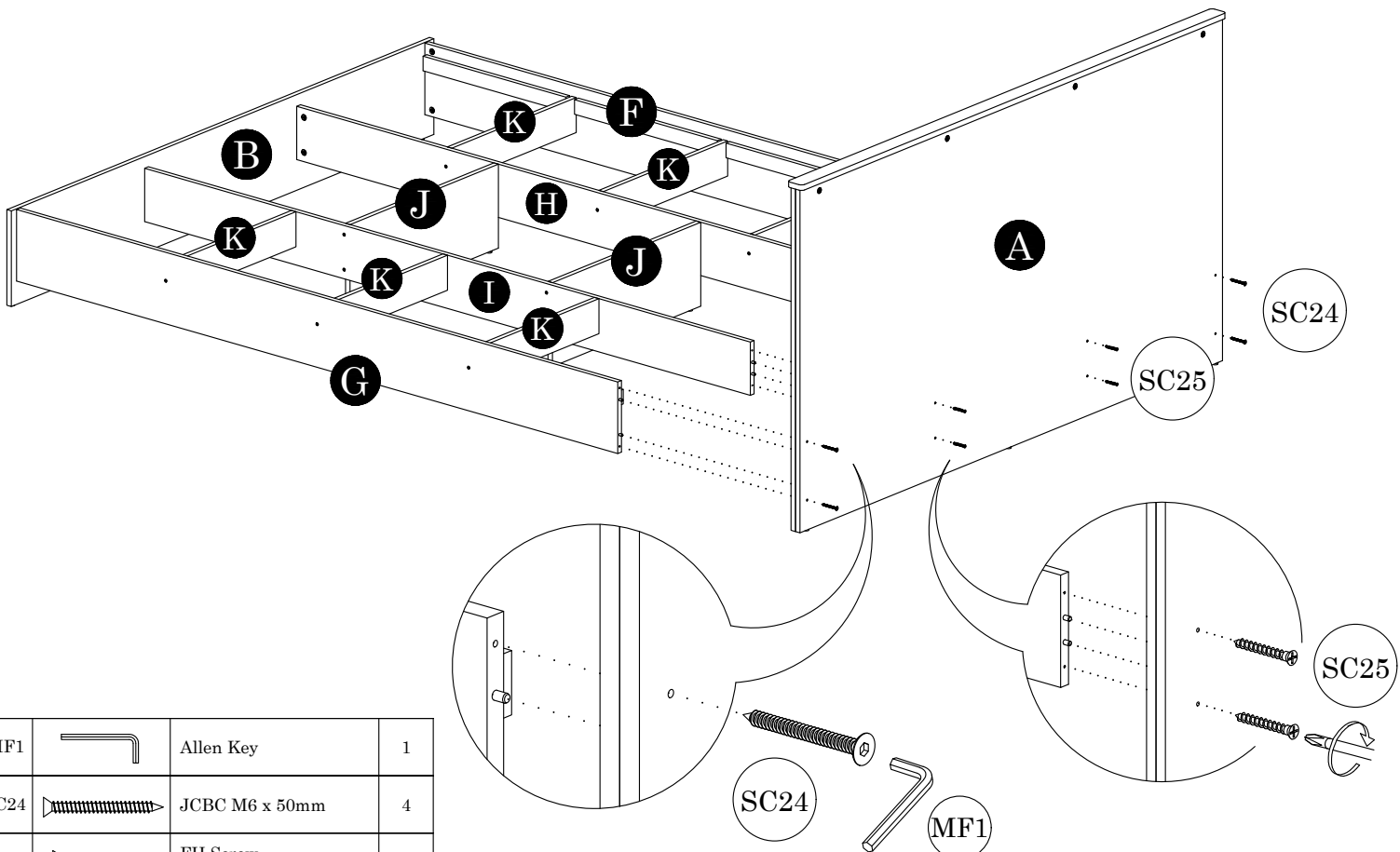

# STEP 8



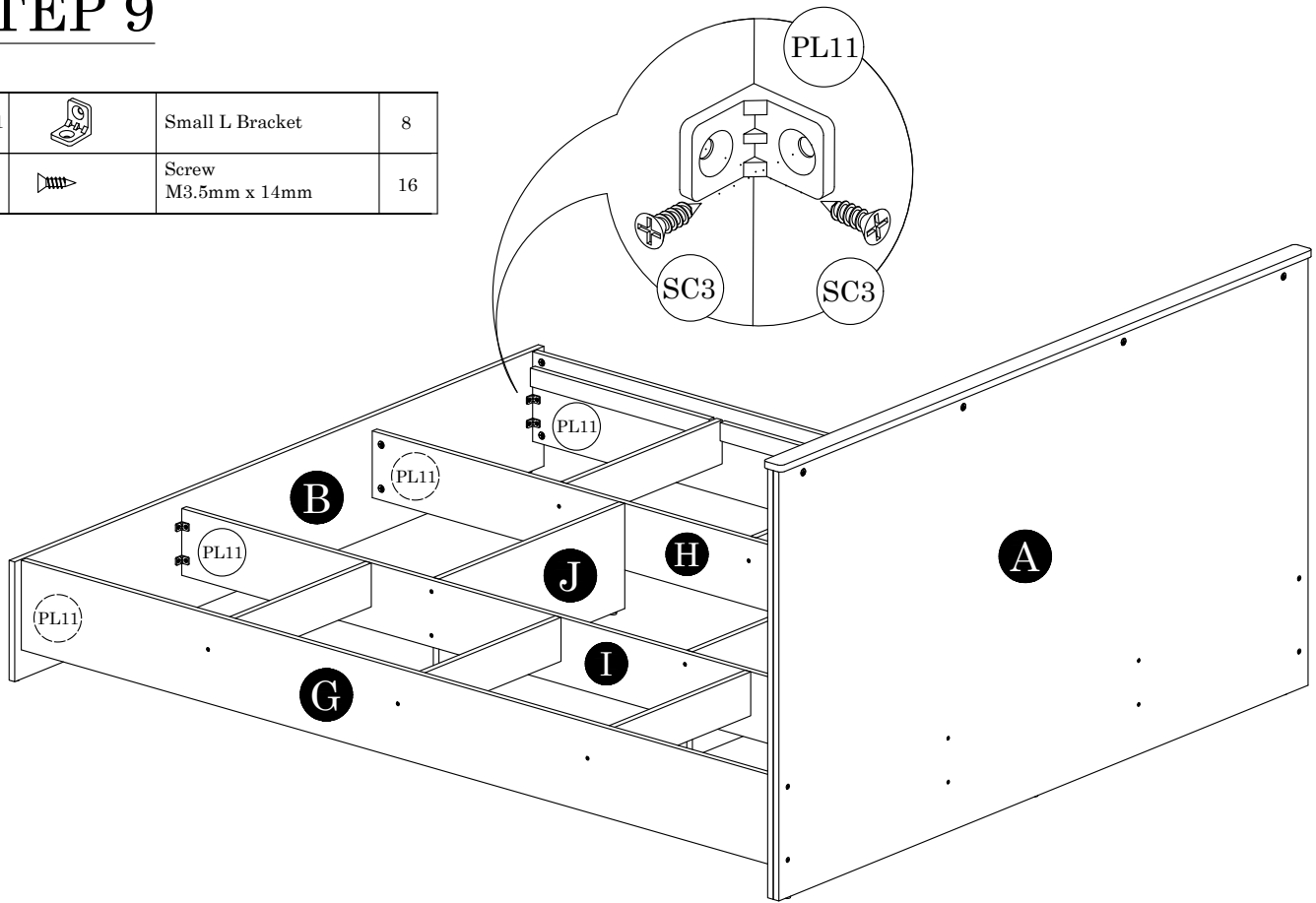

# STEP 9

|      |   |                        |    |
|------|---|------------------------|----|
| PL11 |  | Small L Bracket        | 8  |
| SC3  |  | Screw<br>M3.5mm x 14mm | 16 |

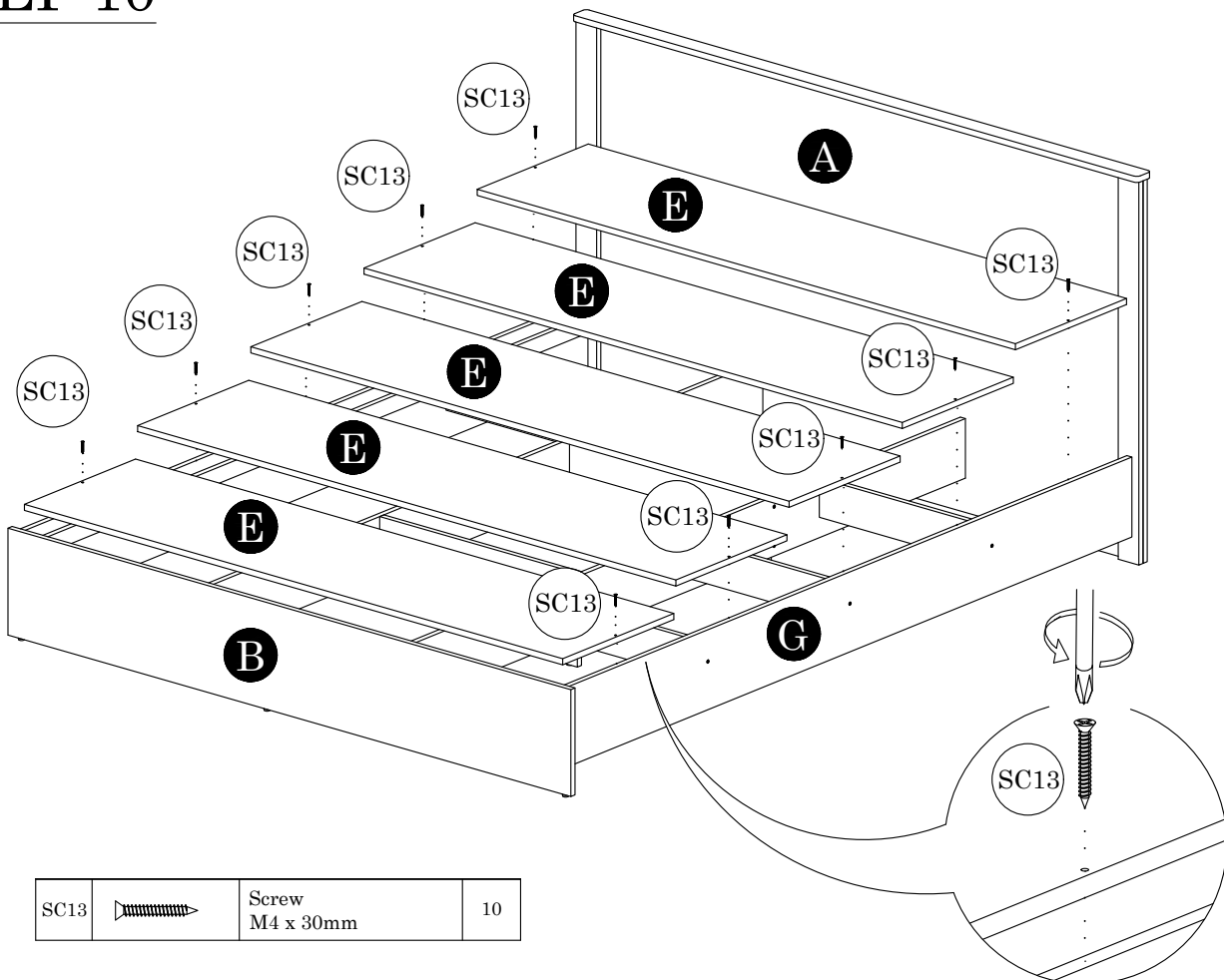

# STEP 10



|      |   |                    |    |
|------|---|--------------------|----|
| SC13 |  | Screw<br>M4 x 30mm | 10 |
|------|---|--------------------|----|