

ASSEMBLY INSTRUCTIONS

383-000057



IMPORTANT

PLEASE READ BEFORE YOU CONTINUE FURTHER

1. MATERIAL USE LAMINATED PARTICLE BOARD, TO CLEAN USE SOFT, DRY CLOTH.
2. DO NOT USE DETERGENT OR CHEMICAL AVOID CONTACT WITH WATER AND DIRECT SUNLIGHT.
3. TO BE ASSEMBLED ON A SOFT, DRY, CLEAN SMOOTH SURFACE.
4. DO NOT USE ANY TOOLS OTHER THAN THOSE SHOWN.
5. USE OF POWER TOOLS TO ASSEMBLE THIS PRODUCT WILL INVALIDATE ANY CLAIM AND MAY DAMAGE THIS PRODUCT MAKING IT UNSAFE.
6. BEFORE STARTING ASSEMBLY PLEASE VERIFY IF ALL PARTS AND HARDWARE ARE INCLUDED.

HARDWARE LIST			QTY (pcs)
DH8		Door Hinges 5/8	6 Sets
DW4		Wood Dowel 6 x 25mm	20
HD6		Plastic Handle 128mm	2
LG1		Leg Pin	4
MF2		Nail	35 (+3)
PF11		Small L Bracket	2
SC3		Screw M3.5 x 14mm	44
SC11		Screw M4 x 25mm	4
SC25		FH Screw M5 x 40mm	16
SH4		Plastic Shelf Support with Steel Pin	8

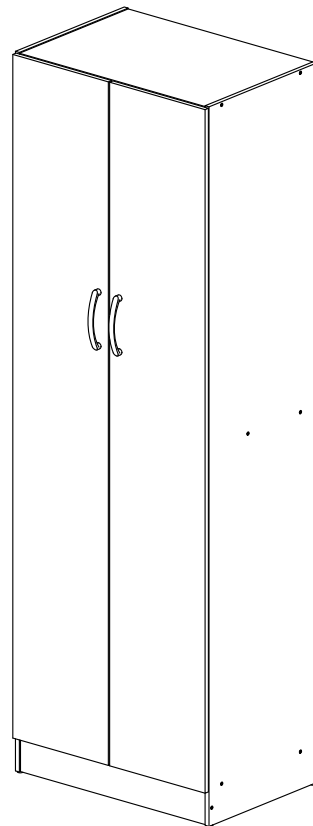

Parts List		QTY
A	Side Panel (L)	1 pc
B	Side Panel (R)	1 pc
C	Door Panel (L)	1 pc
D	Door Panel (R)	1 pc
E	Top Panel	1 pc
F	Bottom Panel	1 pc
G	Shelf Panel	1 pc
H	Free Shelf Panel	2 pcs
I	Bottom Crossbar	2 pcs
J	Backboard	2 pcs

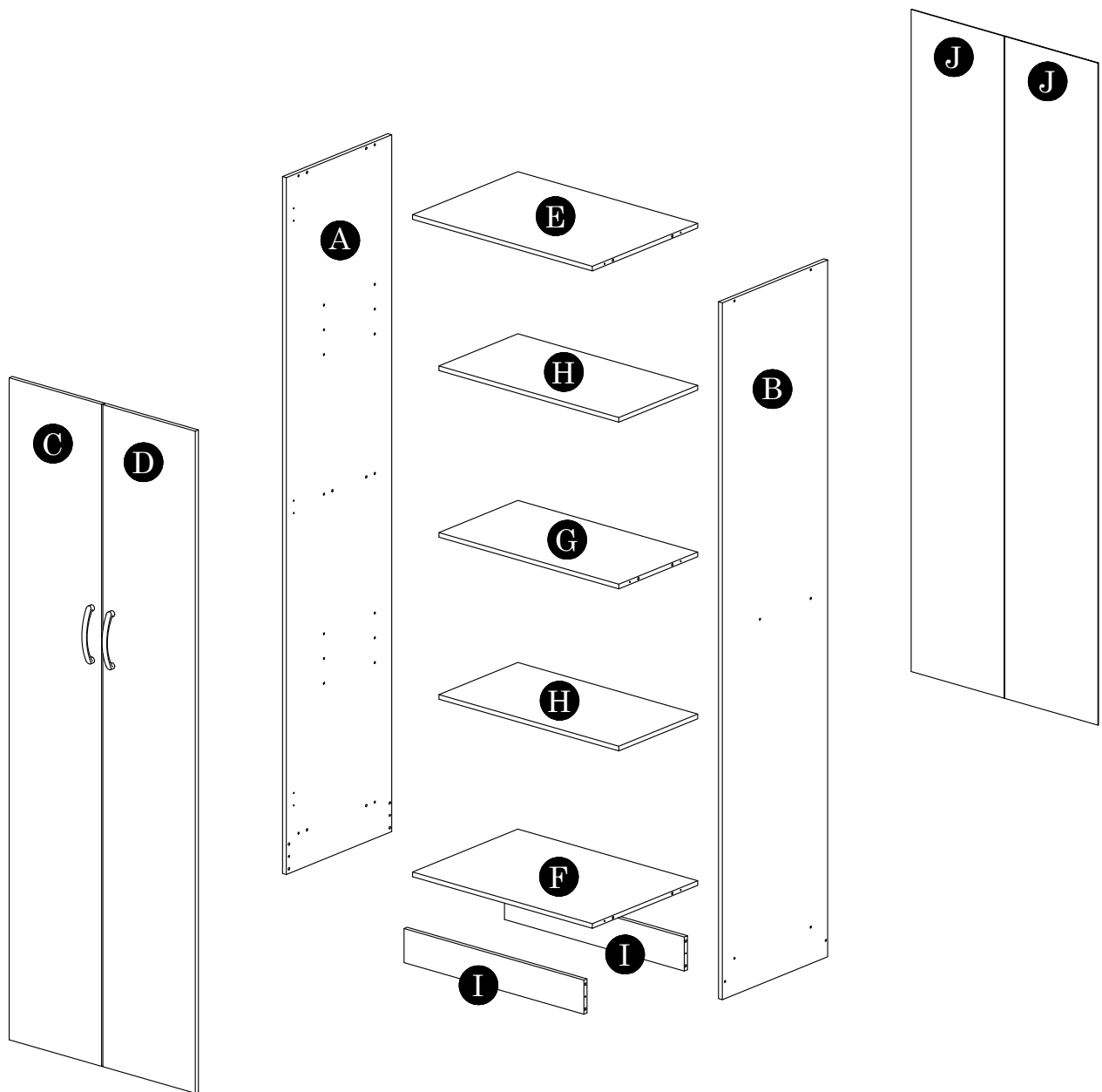

STEP 1

DW4		Wood Dowel 6 x 25mm	20
-----	---	------------------------	----

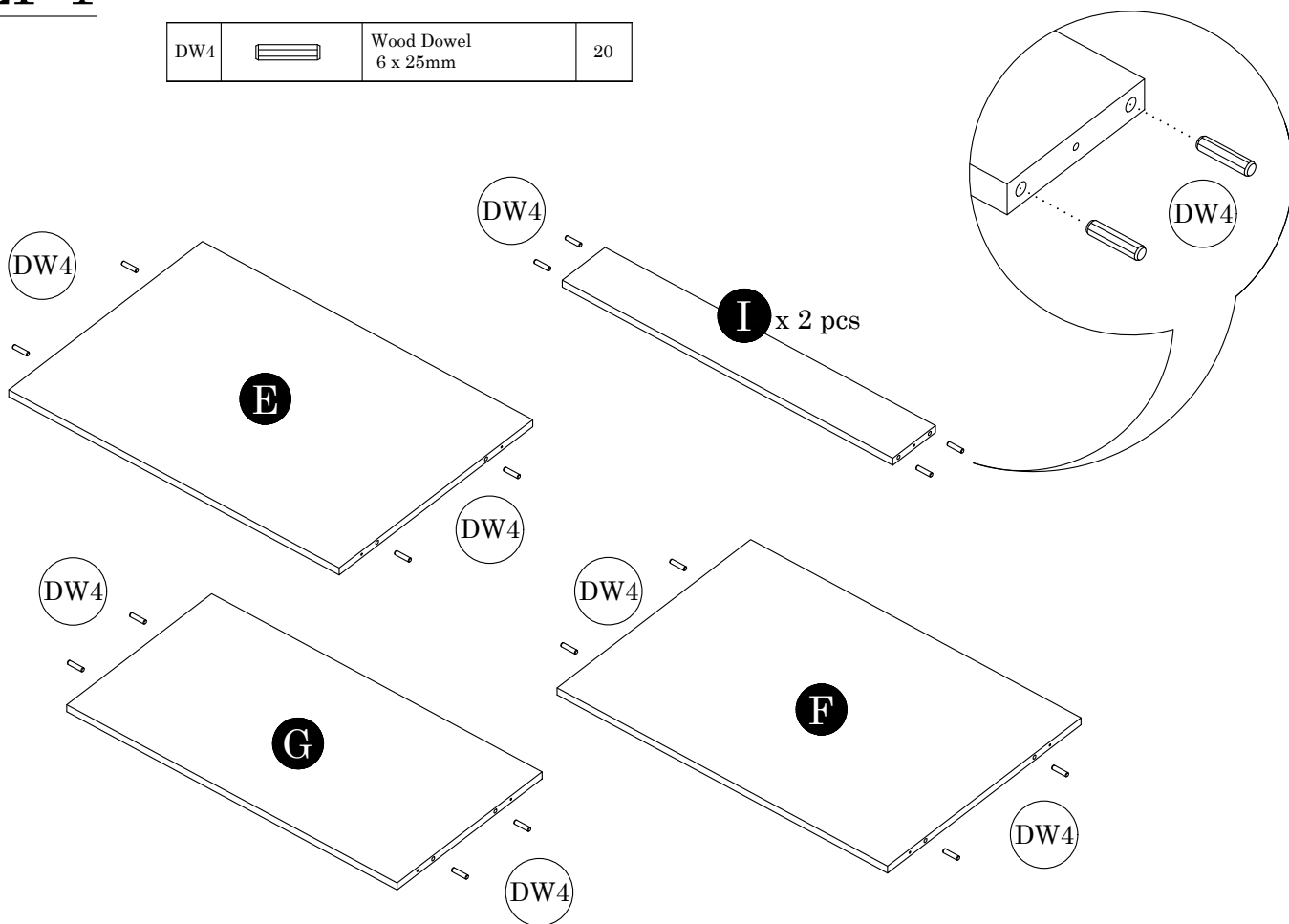

STEP 2

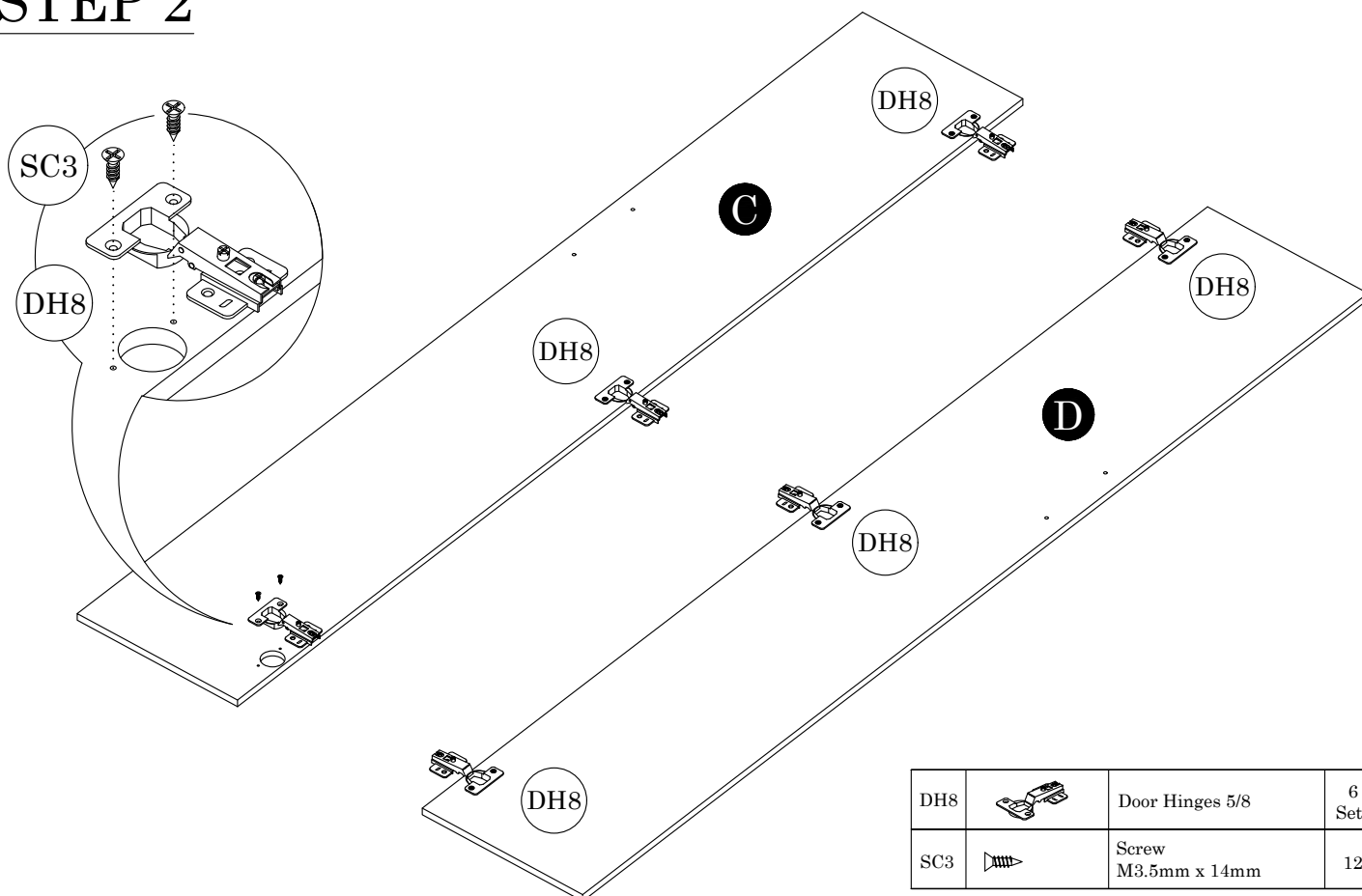

DH8		Door Hinges 5/8	6 Sets
SC3		Screw M3.5mm x 14mm	12



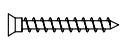

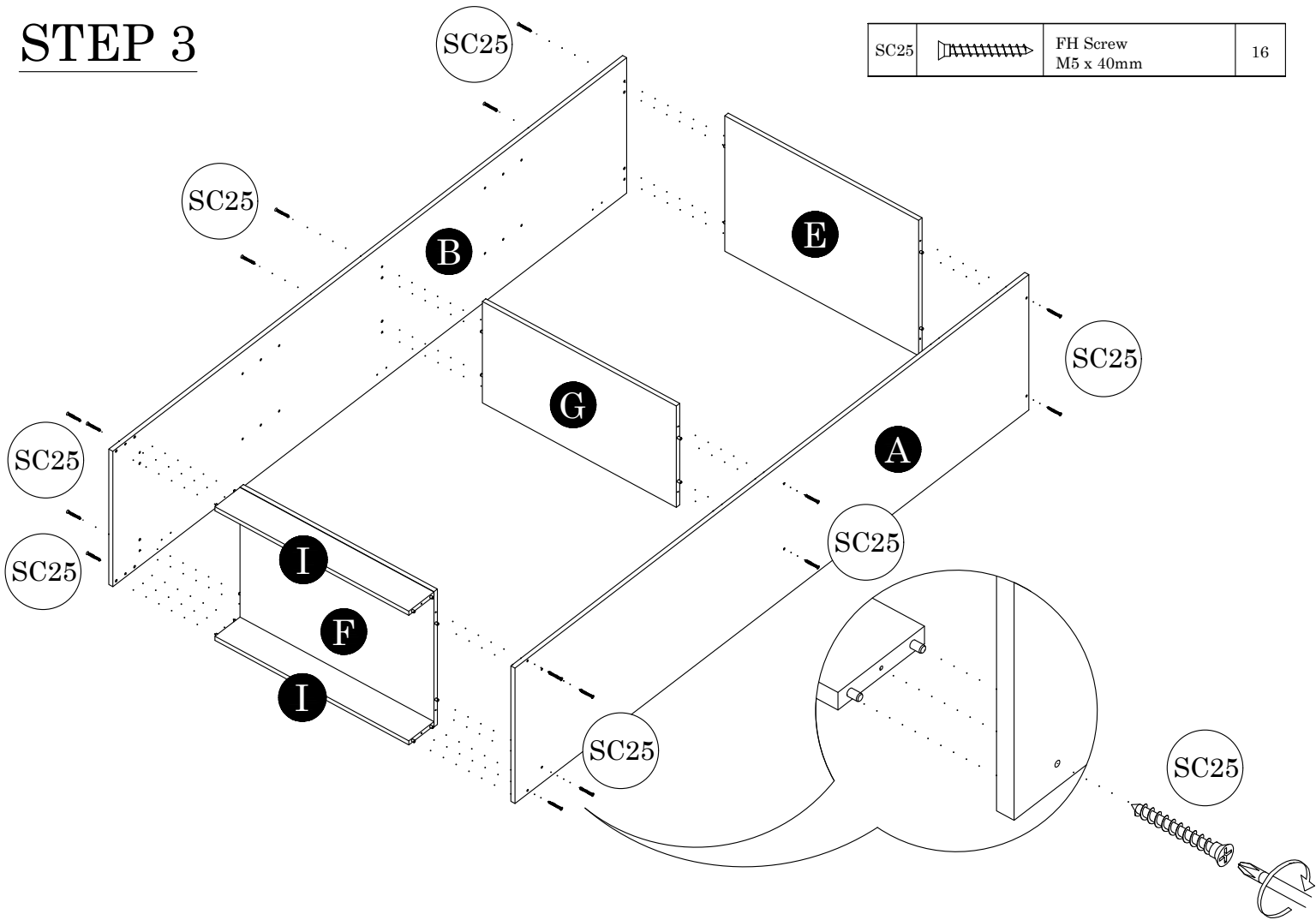
STEP 3

SC25		FH Screw M5 x 40mm	16
------	--	-----------------------	----

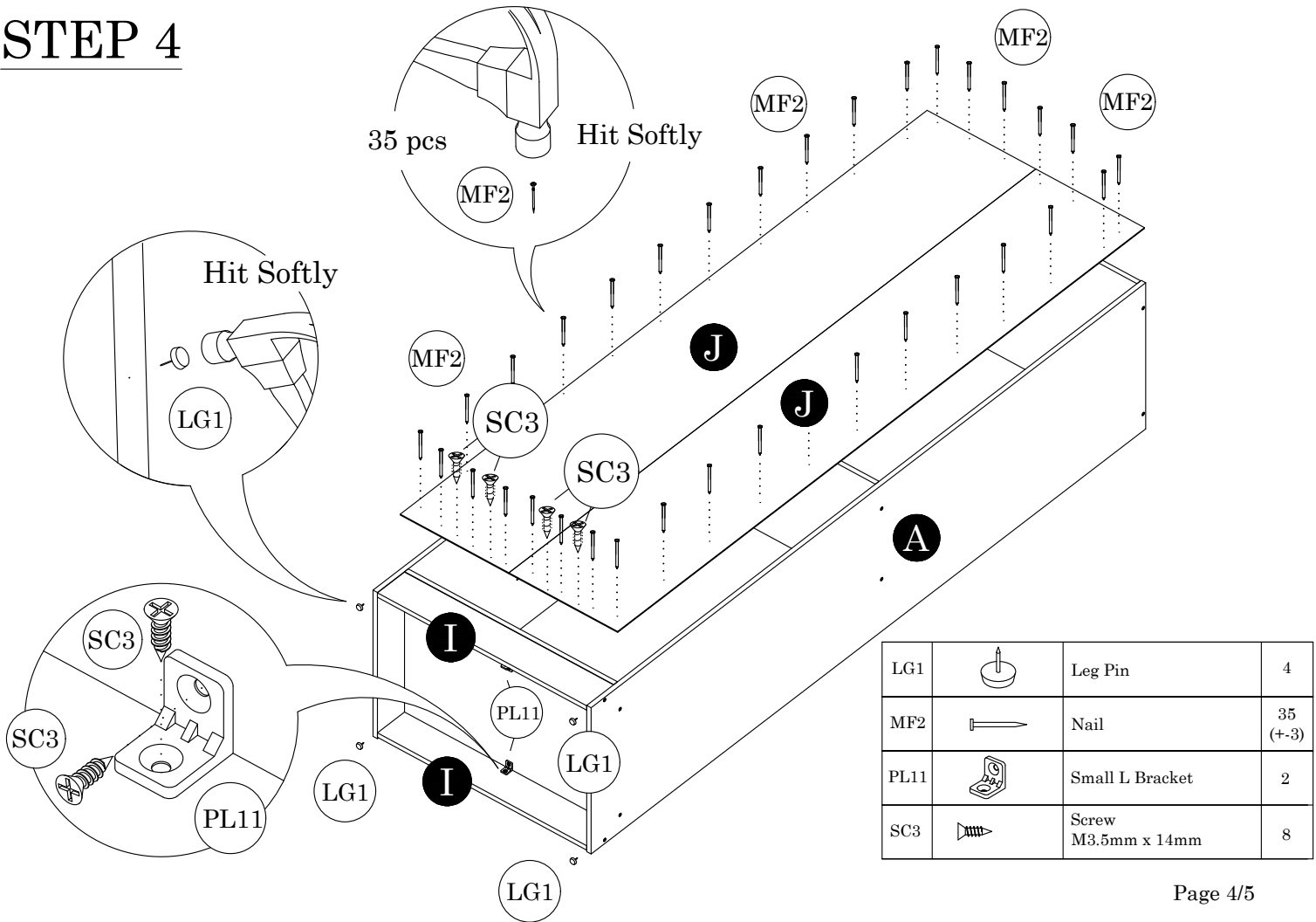

STEP 4



LG1		Leg Pin	4
MF2		Nail	35 (+3)
PL11		Small L Bracket	2
SC3		Screw M3.5mm x 14mm	8

