

367-000017

INSTALL DRAWING

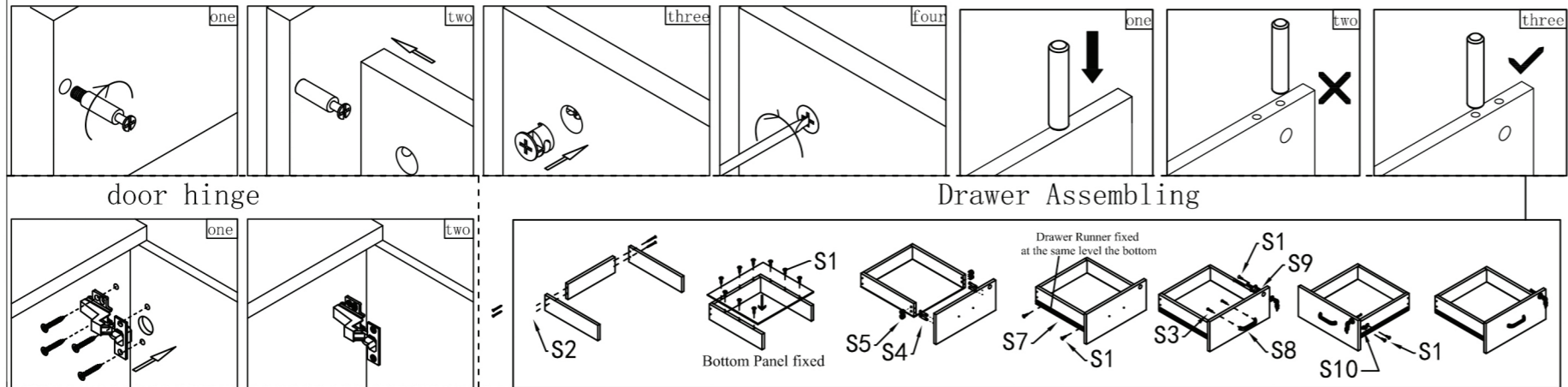





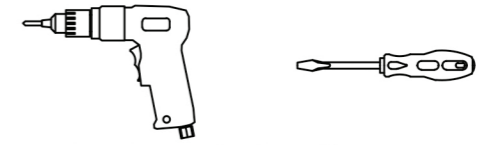

three in one sketch

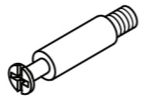

Installation tool

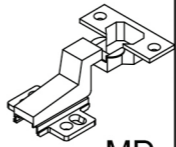

Installs the hardware

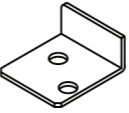
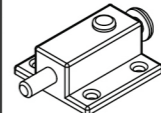
No.	S1	S2	S3	S4	S5	S6	S7	S8	S9	S10	S11
Accessories	3.5X14 	3.5X20 	4X18 				128V 	MD 			
Number	58	8	8	62	62	24	4	8	2	3	1